



ESL 50-12FTHT

12V - 50 Ah

Electrical Specifications @ 25°C

Nominal Voltage	12 V	
Capacity	C10 / 1,80V	50,0 Ah
	C5 / 1,75V	45,3 Ah
	C3 / 1,70V	37,2 Ah
	C1 / 1,60V	35,2 Ah
Self Discharge @20°C	per Month	≈ 3 %
Resistance	fully charged	≈ 8 mΩ
Standby use	+/- 1%	2,27-2,30 V/c
Temp. correction factor	+/- 1%	-3 mV /°C /c
Cyclic use	+/- 1%	2,40-2,45 V/c
Max. charging current	+/- 1%	15 A
Temp. correction factor		-3 mV /°C /c

Other Specifications @ 25°C

Design Life @35°C	12 Years	
Dimensions (LxWxH1) ± 3	277x106x222 mm	
Total Height (H2)	229 mm	
Operating temp.	-30 ~ +80 °C	
Charge Operation temp	-10 ~ 70 °C	
Container	ABS	
Separator	Fiberglass	
Electrolyte	Acid	
Terminal / Length	M6 / 16 bold / mm	
Optional terminal types	-	
Torque setting	8 Nm	
Weight (±2%)	17,3 kg	

Innovative Features

- Wide operating temperature range : -30 °C to +80 °C
- Patented anti-corrosion grid technology
- Special Battery separator technology
- Special Containers & lids with thermostability
- Special structure design with compression resistance and impact resistance
- Save 50% cost of air conditioners power consumption
- 100% air conditioner maintenance saving
- 30% CO2 gas emission reduce;
- 100% condensing agent saving, no condensing agent pollution

Dimensions / Pole settings

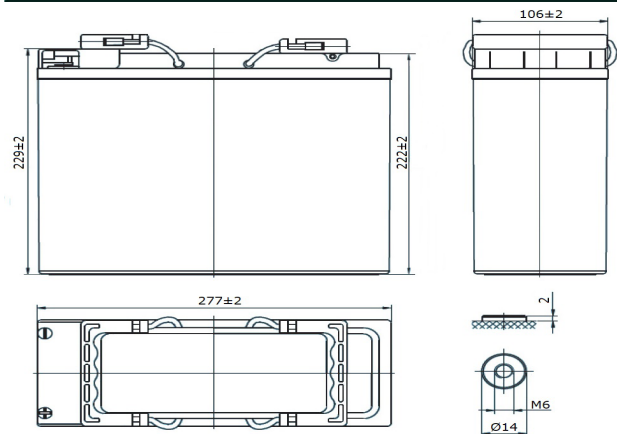

Constant Current Discharge - Ampere @ 25°C

V/Cell	5m	10m	15m	20m	25m	30m	35m	40m	45m	50m	55m	60m	90m	2h	3h	4h	5h	6h	7h	8h	9h	10h	12h	20h
1,80	/	77,0	66,0	58,2	53,4	49,0	44,9	42,4	38,8	36,4	34,2	32,4	22,3	16,8	12,1	10,3	9,00	7,89	6,92	6,13	5,48	5,00	4,28	2,66
1,75	/	85,0	71,6	62,1	56,5	51,2	46,7	43,6	40,1	37,5	35,0	33,1	22,9	17,1	12,3	10,4	9,06	7,94	6,96	6,16	5,50	5,01	4,29	2,67
1,70	/	93,0	77,1	66,0	59,1	53,3	48,6	44,8	41,4	38,5	35,8	33,8	23,4	17,4	12,4	10,5	9,13	7,99	7,00	6,19	5,52	5,02	4,30	2,67
1,65	/	101	82,7	70,1	62,2	55,5	50,4	46,1	42,7	39,5	36,7	34,5	23,9	17,7	12,6	10,6	9,19	8,04	7,04	6,22	5,54	5,03	4,31	2,68
1,60	/	109	88,2	74,3	65,3	57,6	52,3	47,5	44,0	40,6	37,6	35,2	24,5	18,0	12,8	10,7	9,26	8,09	7,08	6,25	5,56	5,04	4,32	2,69

Constant Power Discharge - Watts per cell @ 25°C

V/Cell	5m	10m	15m	20m	25m	30m	35m	40m	45m	50m	55m	60m	90m	2h	3h	4h	5h	6h	7h	8h	9h	10h	12h	20h
1,80	/	147	127	113	103	93,4	86,1	79,1	74,1	69,6	65,9	61,7	46,8	37,0	27,0	21,5	17,9	15,6	13,5	12,0	10,8	9,79	8,48	5,36
1,75	/	158	135	119	108	97,9	89,7	83,4	76,9	72,0	68,0	63,5	47,4	37,5	27,4	21,8	18,1	15,7	13,6	12,1	10,9	9,87	8,54	5,4
1,70	/	168	143	125	113	102	93,3	86,7	79,8	74,4	70,1	65,3	48,1	37,9	27,9	22,1	18,2	15,9	13,7	12,2	11,0	9,95	8,6	5,44
1,65	/	179	151	131	118	107	97,2	90,1	82,7	76,8	72,2	67,1	48,7	38,4	28,2	22,4	18,4	16,0	13,8	12,3	11,1	10,0	8,66	5,48
1,60	/	190	159	138	123	111	101	93,6	85,6	79,2	74,3	69,0	49,3	38,9	28,5	22,7	18,5	16,1	13,9	12,4	11,2	10,1	8,72	5,52

EN2023-10

Your Wing Dealer :



Wetac Stand-By B.V.
Wetac Stand-By CZ
Wetac UK Ltd.
Wetac Swiss GmbH
Wetac Hellas S.A.
BSOL Batteriesysteme GmbH

orderdesk.nl@wetac.com
orderdesk.cz@wetac.com
orderdesk.uk@wetac.com
info@wetac.ch
info@wetac.gr
info@bsol.de

+31 (0)318 696 190
+420 732 172 800
+44 (0)1204 366 728
+41 (0) 61 6437066
+30 210 2446 848
+49 (0)211 387 899-40

